

PRELIMINARY SPEC

Part Number: APA3010P3BT

Features

- 3.0mmx1.0mm RIGHT ANGLE SMT LED, 2.0mm THICKNESS.
- MECHANICALLY AND SPECTRALLY MATCHED TO THE INFRARED EMITTING LED LAMP.
- BLUE TRANSPARENT LENS.
- PACKAGE : 2000PCS / REEL.
- MOISTURE SENSITIVITY LEVEL : LEVEL 3.
- RoHS COMPLIANT.

Description

Made with NPN silicon phototransistor chips.

Package Dimensions

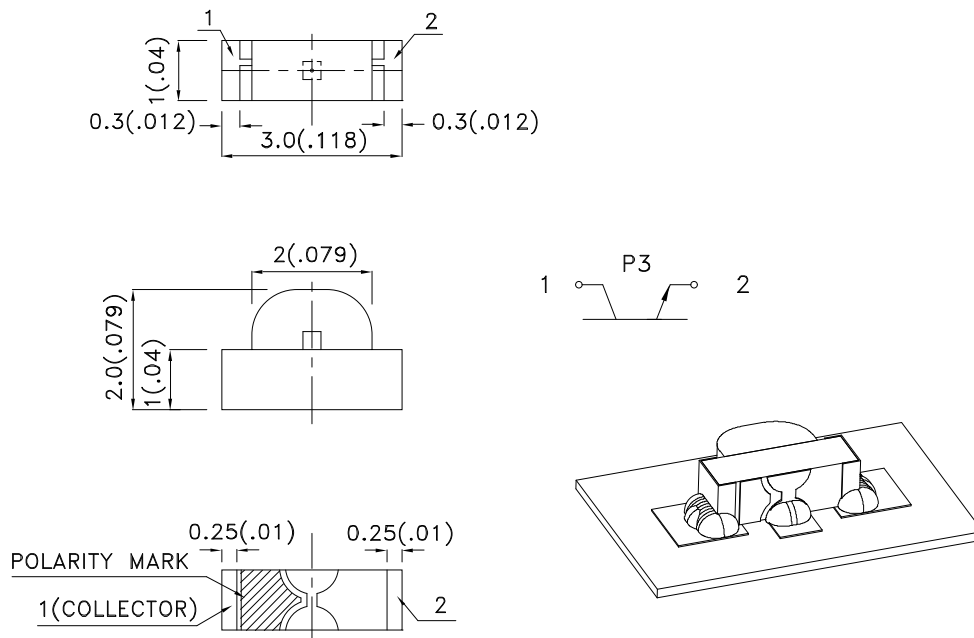

Notes:

1. All dimensions are in millimeters (inches).
2. Tolerance is $\pm 0.15(0.006")$ unless otherwise noted.
3. Specifications are subject to change without notice.
4. The device has a single mounting surface. The device must be mounted according to the specifications.



Electrical / Optical Characteristics at TA=25°C

Symbol	Parameter	Min.	Typ.	Max.	Units	Test Conditions
V _{BR CEO}	Collector-to-Emitter Breakdown Voltage	30			V	I _C =100uA E _e =0mW/c m ²
V _{BR ECO}	Emitter-to-Collector Breakdown Voltage	5			V	I _E =100uA E _e =0mW/c m ²
V _{CE (SAT)}	Collector-to-Emitter Saturation Voltage			0.8	V	I _C =2mA E _e =20mW/c m ²
I _{CEO}	Collector Dark Current			100	nA	V _{CE} =10V E _e =0mW/c m ²
T _R	Rise Time (10% to 90%)		15		us	V _{CE} = 5V I _C =1mA R _L =1000Ω
T _F	Fall Time (90% to 10%)		15		us	
I _(ON)	On State Collector Current	0.2	0.8		mA	V _{CE} = 5V E _e =1mW/c m ² λ=940nm
2θ _{1/2}	Viewing Angle		110		deg	

Absolute Maximum Ratings at TA=25°C

Parameter	Max.Ratings
Collector-to-Emitter Voltage	30V
Emitter-to-Collector Voltage	5V
Power Dissipation at (or below) 25°C Free Air Temperature	100mW
Operating Temperature	-40°C To +85°C
Storage Temperature	-40°C To +85°C

APA3010P3BT

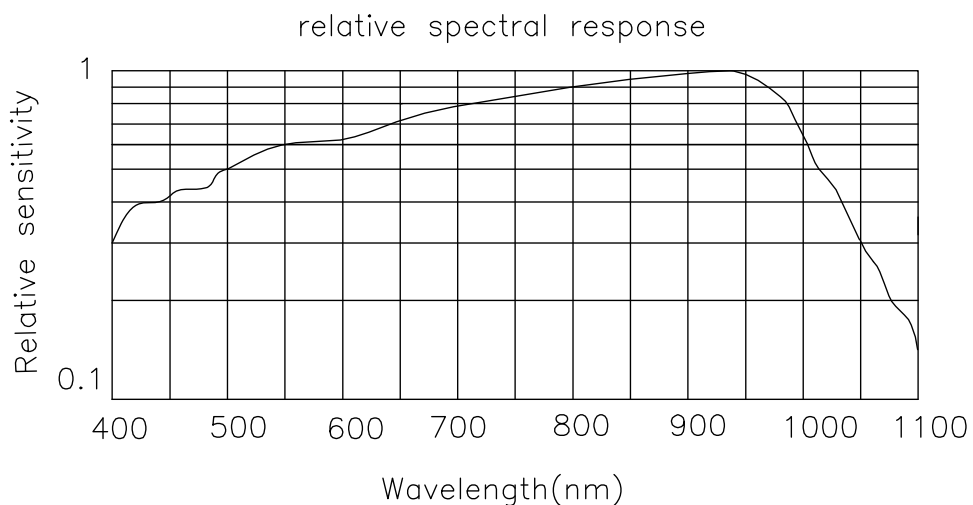

APA3010P3BT

Reflow Soldering Profile For Lead-free SMT Process.

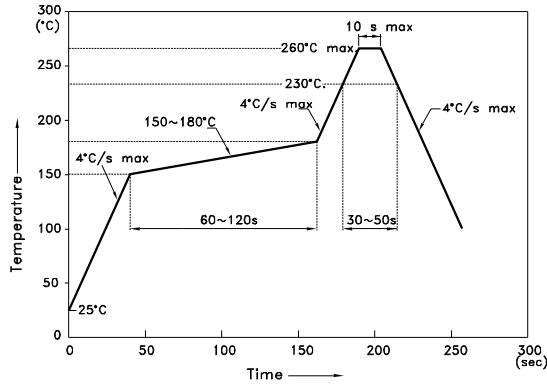

NOTES:

1. We recommend the reflow temperature 245°C(+/-5°C). The maximum soldering temperature should be limited to 260°C.
2. Don't cause stress to the epoxy resin while it is exposed to high temperature.
3. Number of reflow process shall be 2 times or less.

Recommended Soldering Pattern (Units : mm; Tolerance: ± 0.1)

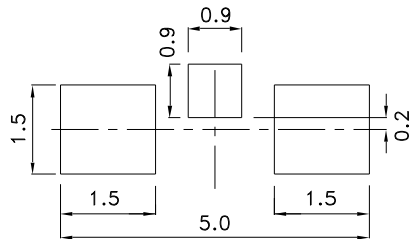

Tape Specifications (Units : mm)

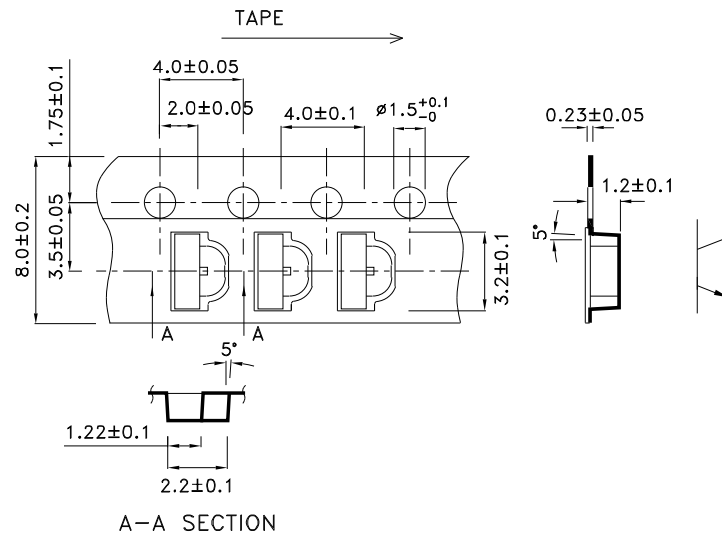

Kingbright

PACKING & LABEL SPECIFICATIONS

APA3010P3BT

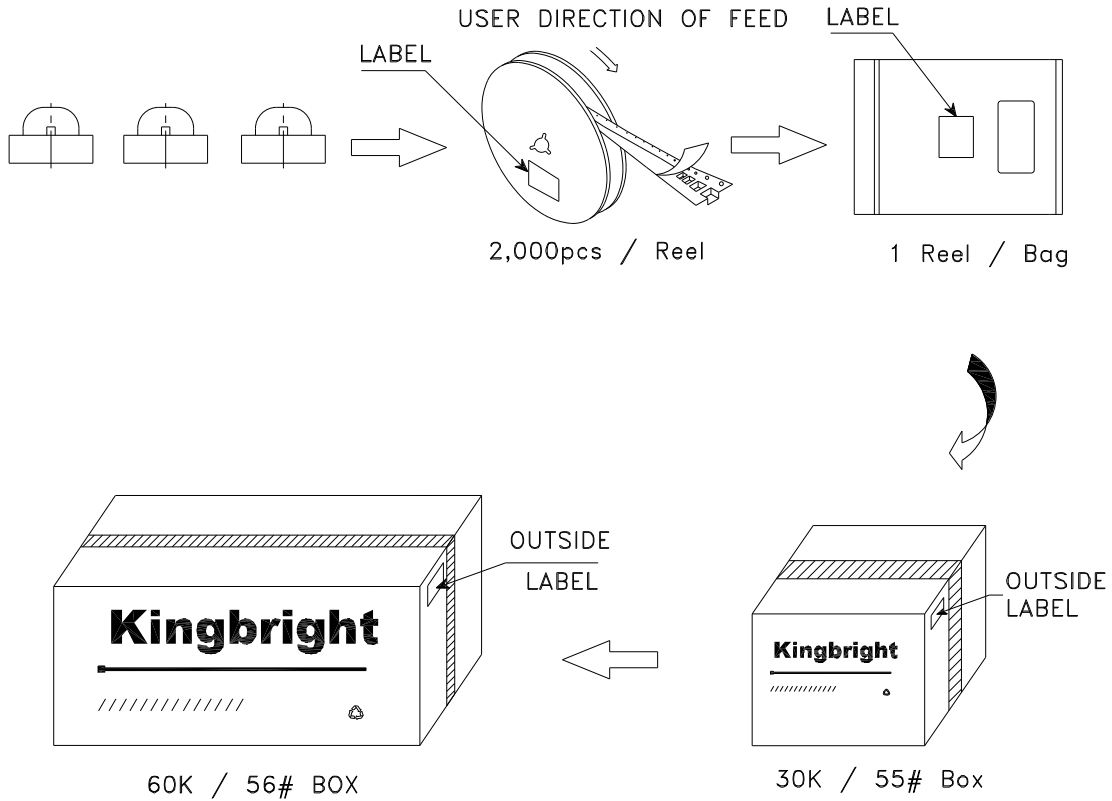

Kingbright	
P/NO: APA3010xxx	
QTY: 2,000 pcs	Q.C. Q C xx xx xxxx PASSED
S/N: XXXX	
CODE: XXX	
LOT NO:	
 xxxxxxxxxxxxxxxxxxxxxxxxxxxx	
RoHS Compliant	